



■ Features :

- Universal AC input / Full range
- Built-in 5V/0.3A, 12V/0.8A auxiliary power
- Built-in active PFC function, PF>0.98
- Protections: Short circuit / Overload / Over voltage / Over temperature
- High Power density 21.4w/inch³
- Forced air cooling by built-in DC fan with fan speed control
- Low profile:1U height
- Remote control for single unit
- Built-in remote sense function
- Output voltage trimming function
- Hot-swap operation
- PMBus serial communications
- AC OK, DC OK signal, fan fail, OTP alarm signal
- 3 years warranty

■ Description :

The RCP-2000 series are state of the art AC/DC front-end rectifiers with 1U compact size and 21.4 W/in³ of high power density. They can provide up to 2000W per unit for the applications of servers, information technology equipment, networking, telecommunications, and wide range of industrial applications using distributed power architecture. Equipped with hot-swap function and PMBus communication protocol, RCP-2000 can be assembled in 1U 19" rack and controlled/monitored by external device such as monitoring unit (RCP-CMU-1) or PC.



SPECIFICATION - Single Unit

MODEL	RCP-2000-12	RCP-2000-24	RCP-2000-48	
OUTPUT	DC VOLTAGE	12V	24V	48V
	RATED CURRENT	100A	80A	42A
	CURRENT RANGE	0 ~ 100A	0 ~ 80A	0 ~ 42A
	RATED POWER	1200W	1920W	2016W
	RIPPLE & NOISE (max.) Note.2	150mVp-p	200mVp-p	300mVp-p
	VOLTAGE ADJ. RANGE	10.5 ~ 14V	21 ~ 28V	42 ~ 56V
	VOLTAGE TOLERANCE Note.3	±2.0%	±1.0%	±1.0%
	LINE REGULATION	±1.0%	±0.5%	±0.5%
	LOAD REGULATION	±1.0%	±0.5%	±0.5%
	SETUP, RISE TIME	1500ms, 60ms/230VAC at full load		
HOLD UP TIME (Typ.)	16ms/230VAC at 75% load 10ms/230VAC at full load			
INPUT	VOLTAGE RANGE Note.5	90 ~ 264VAC 127 ~ 370VDC		
	FREQUENCY RANGE	47 ~ 63Hz		
	EFFICIENCY (Typ.)	86%	90.5%	92%
	AC CURRENT (Typ.)	13A/115VAC 7A/230VAC	16A/115VAC 10A/230VAC	16A/115VAC 10A/230VAC
	INRUSH CURRENT (Typ.)	COLD START 50A		
	LEAKAGE CURRENT	<1.1mA / 230VAC		
PROTECTION	OVERLOAD	105 ~ 125% rated output power Protection type : Constant current limiting, unit will shut down o/p voltage after 5 sec. re-poewr on to recover		
	OVER VOLTAGE	14.7 ~ 17.5V	29.5 ~ 35V	57.6 ~ 67.2V
	OVER TEMPERATURE	80°C ±5°C (TSW1) detect on heatsink of power bridge 85°C ±5°C (TSW2) detect on heatsink of o/p diode Protection type : Shut down o/p voltage, recovers automatically after temperature goes down		
FUNCTION	AUXILIARY POWER	5V @ 0.3A, 12V @ 0.8A		
	REMOTE ON/OFF CONTROL	By electrical signal or dry contact ON:short OFF:open		
	REMOTE SENSE	Compensate voltage drop on the load wiring up to 0.5V		
	DC OK SIGNAL	The isolated TTL signal out, refer to function manual		
	AC FAIL SIGNAL	The isolated TTL signal out, refer to function manual		
	OUTPUT VOLTAGE TRIM	Adjustment of output voltage, possible between 90 ~ 110% of rated output		
	OVER TEMP WARNING	Logic " High" for over temperature warning, refer to function manual, isolated signal		
	FAN FAIL SIGNAL	The isolated TTL signal out, refer to function manual		
ENVIRONMENT	WORKING TEMP.	-25 ~ +70°C (Refer to output load derating curve)		
	WORKING HUMIDITY	20 ~ 90% RH non-condensing		
	STORAGE TEMP., HUMIDITY	-40 ~ +85°C, 10 ~ 95% RH		
	TEMP. COEFFICIENT	±0.03%/°C (0 ~ 50°C)		
	VIBRATION	10 ~ 500Hz, 2G 10min./1cycle, 60min. each along X, Y, Z axes		

MODEL	RCP-2000-12	RCP-2000-24	RCP-2000-48
SAFETY & EMC (Note 4)	SAFETY STANDARDS		
	UL60950-1, TUV EN60950-1 approved		
	WITHSTAND VOLTAGE		
	I/P-O/P:3KVAC I/P-FG:1.5KVAC O/P-FG:0.7KVDC		
	ISOLATION RESISTANCE		
	I/P-O/P, I/P-FG, O/P-FG:100M Ohms / 500VDC / 25°C / 70% RH		
OTHERS	EMI CONDUCTION & RADIATION		
	Compliance to EN55022 (CISPR22)		
	HARMONIC CURRENT		
	Compliance to EN61000-3-2,-3		
	EMS IMMUNITY		
Compliance to EN61000-4-2,3,4,5,6,8,11, ENV50204, EN61000-6-2 (EN50082-2), heavy industry level, criteria A			
NOTE	MTBF		
	60.1Khrs min. MIL-HDBK-217F (25°C)		
	DIMENSION		
295*127*41mm (L*W*H)			
PACKING			
2Kg;6pcs/13Kg/1.04CUFT			
<p>1. All parameters NOT specially mentioned are measured at 230VAC input, rated load and 25°C of ambient temperature.</p> <p>2. Ripple & noise are measured at 20MHz of bandwidth by using a 12" twisted pair-wire terminated with a 0.1uf & 47uf parallel capacitor.</p> <p>3. Tolerance : includes set up tolerance, line regulation and load regulation.</p> <p>4. The power supply is considered a component which will be installed into a final equipment. The final equipment must be re-confirmed that it still meets EMC directives.</p> <p>5. Derating may be needed under low input voltages. Please check the derating curve for more details.</p> <p>6. Output of all the RCP-2000 modules are connected in parallel in the rack.</p> <p>7. Under parallel operation of more than one rack connecting together, ripple of the output voltage may be higher than the SPEC at light load condition. It will go back to normal ripple level once the output load is more than 10%.</p>			

■ Mechanical Specification (Single Unit)

Case No. 974A Unit:mm

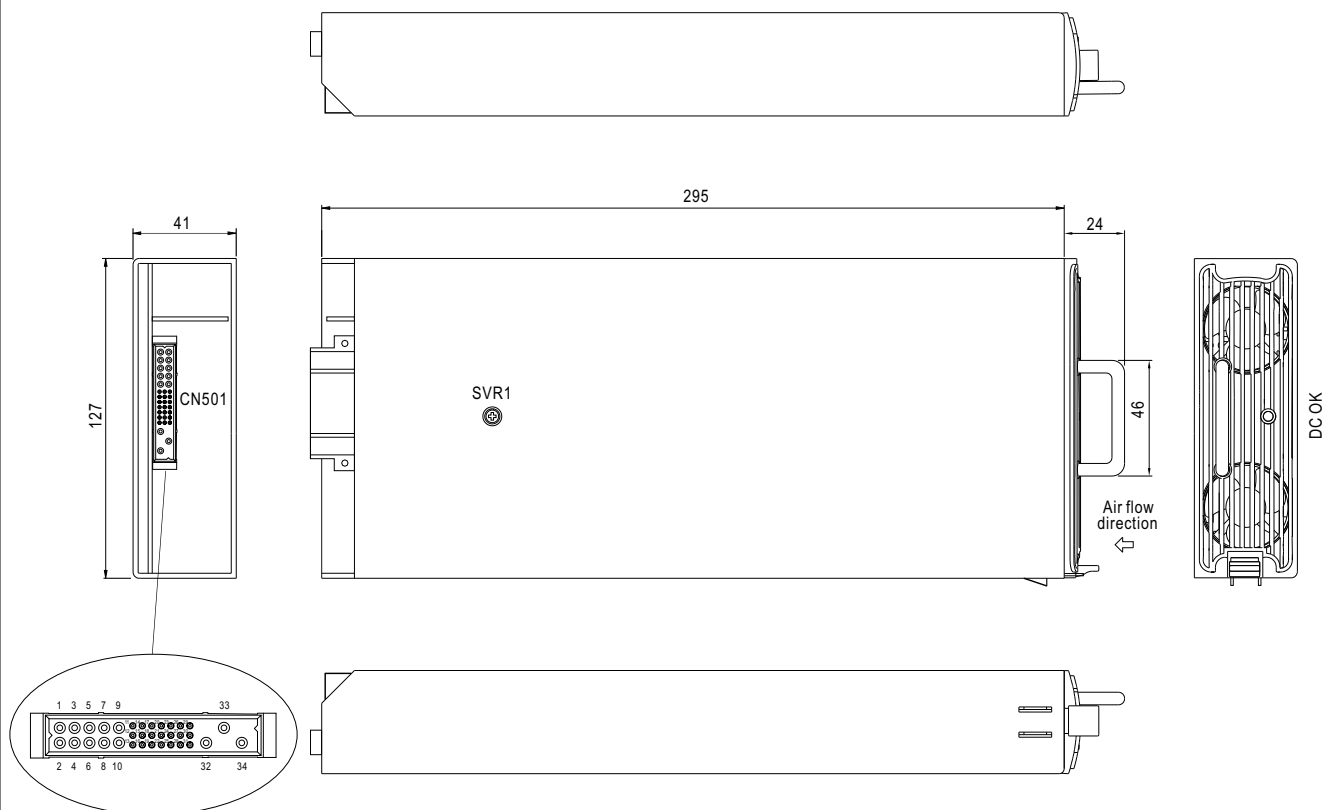

Input / Output Connector Pin No. Assignment(CN501) : Postronic PCIM34W13M400A1

Pin No.	Assignment	Pin No.	Assignment	Pin No.	Assignment	Pin No.	Assignment	Pin No.	Assignment	Pin No.	Assignment	Mating Housing
1,2,3,4	+V	12	DA	17	ON/OFF	22	NC	27	T-ALARM	32	FG ±	Postronic PCIM34W13F400A1
5,6,7,8	-V	13	DB	18	A1	23	SDA	28	FAN-FAIL	33	AC/L	
9	-V(signal)	14	+S	19	A2	24	SCL	29	+5V-AUX	34	AC/N	
10	+V(signal)	15	-S	20	A3	25	AC-OK	30	+12V-AUX			
11	PV	16	A0	21	A4	26	DC-OK	31	GND-AUX			

Block Diagram

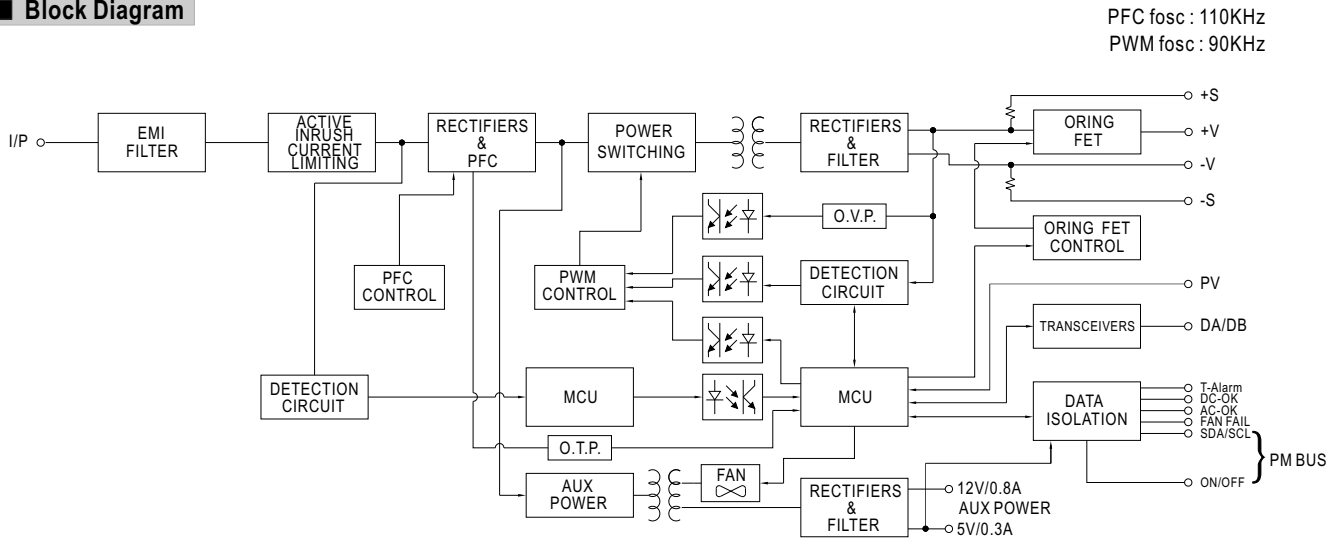

Function Description of CN501

Pin No.	Function	Description
1,2,3,4	+V	Positive output voltage
5,6,7,8	-V	Negative output voltage.
9	-V	-V Signal
10	+V	+V Signal
11	PV	Connection for output voltage trimming. The voltage can be trimmed within its defined range. (Note.1)
12,13	DA,DB	Differential digital signal for parallel control. (Note.1)
14	+S	Positive sensing. The +S signal should be connected to the positive terminal of the load. The +S and -S leads should be twisted in pair to minimize noise pick-up effect. The maximum line drop compensation is 0.5V.
15	-S	Negative sensing. The -S signal should be connected to the negative terminal of the load. The -S and +S leads should be twisted in pair to minimize noise pick-up effect. The maximum line drop compensation is 0.5V.
16,18,19,20,21	A0,A1,A2,A3,A4	PMBus interface address lines. (Note.1)
17	ON/OFF	The unit can turn the output on and off by electrical signal or dry contact. (Note.2)
22	NC	Not use.
23	SDA	Serial Data used in the PMBus interface. (Note.2)
24	SCL	Serial Clock used in the PMBus interface. (Note.2)
25	AC-OK	Low : When the input voltage is $\geq 87V_{rms}$. High : when the input voltage in $\leq 75V_{rms}$. (Note.2)
26	DC-OK	High : When the $V_{out} \leq 80\% \pm 5\%$. Low : When $V_{out} \geq 80\% \pm 5\%$. (Note.2)
27	T-ALARM	High : When the internal temperature (TSW1 or TSW2 open) exceeds the limit of temperature alarm. Low : When the internal temperature (TSW1 or TSW2 short) under the limit temperature. (Note.2)
28	FAN-FAIL	High : When the internal fan fail. Low : When the internal fan is normal. (Note.2)
29	+5V-AUX	Auxiliary voltage output, 4.4~5.5V, referenced to GND-AUX (pin 31). The maximum load current is 0.3A. This output has the built-in "Oring diodes" and is not controlled by the remote ON/OFF control.
30	+12V-AUX	Auxiliary voltage output, 10.8~13.2V, referenced to GND-AUX (pin 31). The maximum load current is 0.8A. This output has the built-in "Oring diodes" and is not controlled by the remote ON/OFF control.
31	GND-AUX	Auxiliary voltage output GND. The signal return is isolated from the output terminals (+V & -V).
32	FG	AC Ground connection.
33	AC/L	AC Line connection.
34	AC/N	AC Neutral connection.

Note1: Non-isolated signal, referenced to the output terminals (-V).

Note2: Isolated signal, referenced to GND-AUX.

Derating Curve

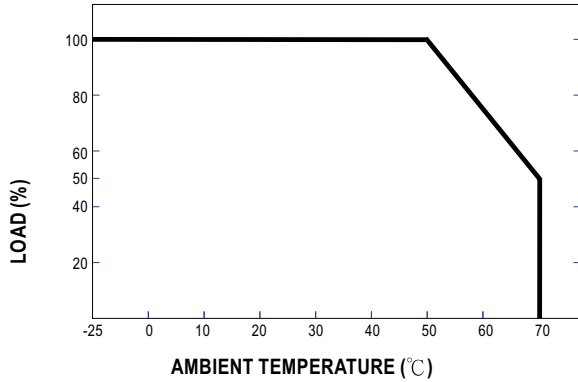

Static Characteristics

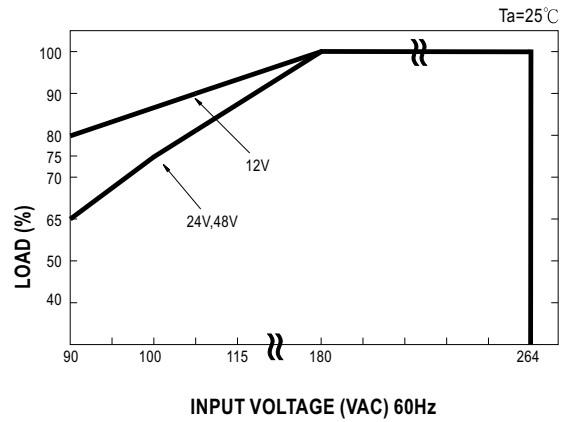

EFFICIENCY vs LOAD (48V Model)

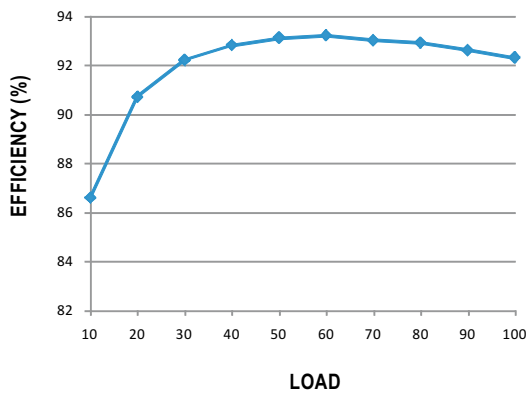

DERATING LOAD(%) VS INPUT VOLTAGE

MODEL \ INPUT/VOLTAGE	180VAC	115VAC	100VAC	90VAC
RCP-2000-12	100%	95%	90%	80%
RCP-2000-24	100%	80%	75%	65%
RCP-2000-48	100%	80%	75%	65%

Function Manual

1. Remote ON/OFF Control

The PSU can be turned ON/OFF together or separately by using the "Remote ON/OFF" function.

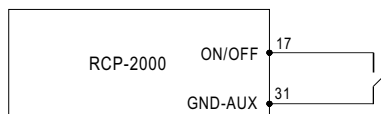

Between ON/OFF and -S	Output
SW Open	OFF
SW Short	ON

2. Voltage Drop Compensation

2.1 Remote Sense

The remote sense compensates voltage drop on the load wiring up to 0.5V.

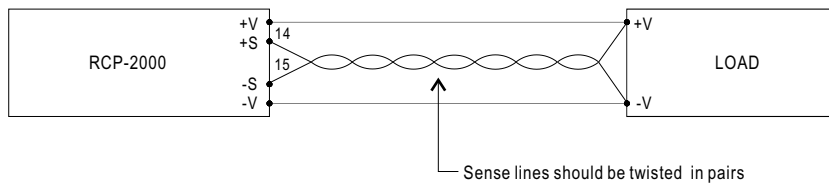

2.2 Local Sense

Notice : The +S,-S have to be connected to the +V,-V terminals locally in order to get the correct output voltage if the remote sensing is not used.

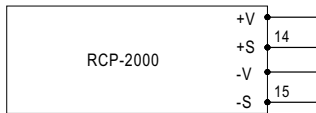

3. Output Voltage Trimming

Output voltage can be trimmed between 90~110% of its rated value by the following method.

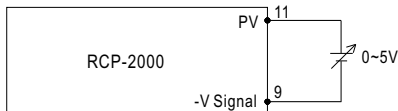

Add on 0~5V external voltage

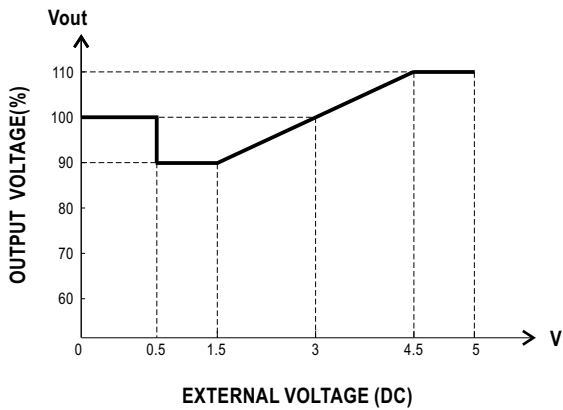

4. Front Panel Indicators & Corresponding Signal at Function Pins

Function	LED	Description	* Signal	PSU Output
AC-OK	GREEN	When input voltage $\geq 87V$	0 ~ 0.5V	ON
AC-NG	RED	When input voltage $\leq 75V$	4.5 ~ 5.5V	OFF
DC-OK	GREEN	When output voltage $\geq 80\% \pm 5\%$ of V_o rated.	0 ~ 0.5V	ON
DC-NG	RED	When output voltage $\leq 80\% \pm 5\%$ of V_o rated.	4.5 ~ 5.5V	ON
T-OK	GREEN	When the internal temperature (TSW1 & TSW2 short) is within safe limit	0 ~ 0.5V	ON
T-ALARM	RED	When the internal temperature (TSW1 or TSW2 open) exceeds the limit of temperature alarm	4.5 ~ 5.5V	OFF

*Signal between function pin and "GND-AUX".