

TWT-RC□□-INV(5)

SPECIFICATIONS

- 3-Phase,3-Wire method
- High performance under small leakage current
- Efficient performance under motor noise
- High filterings by double filters
- Excellent Filtering for Normal Mode and Common Mode Noise



APPLICATIONS

- For INVERTER

SPECIFICATIONS

MODEL (250VAC)	TWT- RC190-NF	TWT- RC260-NF
MODEL (450VAC)	TWT- RC190-450	TWT- RC260-450
RATED CURRENT	190A	260A
RATED VOLTAGE	250 VAC / 450 VAC	
TEST VOLTAGE	1,500V 10mA between I/O terminals and Earth for 1 minute	
INSULATION VOLTAGE	500VDC 300Mohm between I/O terminals and Earth	
LEAKAGE CURRENT	2 mA Max	
TEMPERATURE RISE	40°C Max	
OPERATING TEMPERATURE	-25 ~ +85°C	

Block Diagram

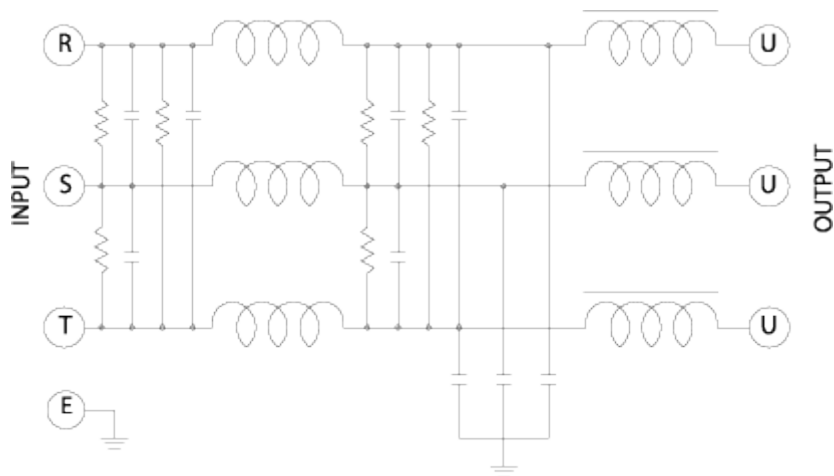

Dimensions (Units:mm)

